

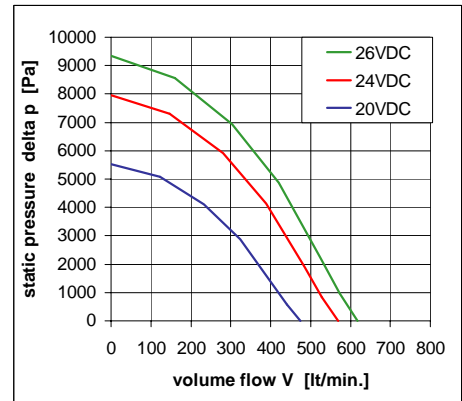

Miniatur Radial Gebläse
Miniature Radial Blower
Ventilateur miniature radial



U51D2-024KX-5 24VDC



U51D2-032KX-5 32VDC

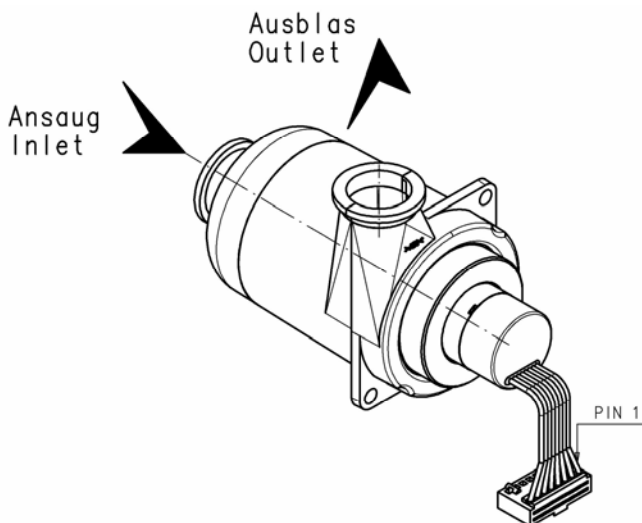
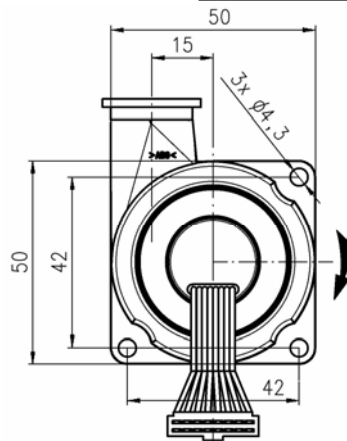
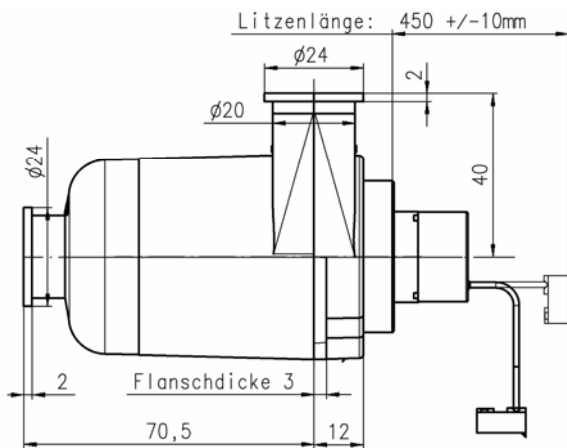
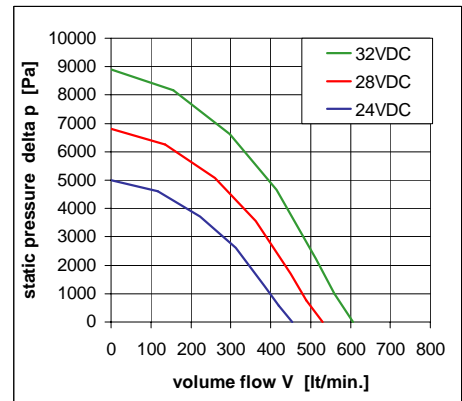

Steckerbelegung / connector pin assignment:

brown	Motorwinding 1	PIN 1
red	Motorwinding 2	PIN 2
orange	Motorwinding 3	PIN 3
yellow	Vhall 4.5...18VDC	PIN 4
green	GND	PIN 5
blue	Hall sensor 1*	PIN 6
violet	Hall sensor 2*	PIN 7
grey	Hall sensor 3*	PIN 8

* internal Pull-up (7...13 kohm) to Pin4

Technische Daten

Motor

Bürstenloser 3-Phasen Motor (mit Hallsensoren) ohne integrierte Elektronik (externe Elektronik nötig)

Achtung:

Um Lebensdauer des Gebläses zu verlängern, nicht über längerem Zeitraum über 42000 u/min. drehen lassen.

Standardluftdichte 1.2kg/m³

Technical data

Motor

Brushless 3-Phasen motor (with hall sensors) without integrated motor controller (external driver required)

Attention:

To extend lifetime of blower, do not run blower beyond 42'000 rpm over longer period of time.

Standard air density 1.2kg/m³

Caractéristiques techniques























Moteur

Moteur à 3 phases, sans brosses (avec hall sensor) sans électronique intégré (électronique externe indispensable)

Attention:

Pour prolonger la vie du ventilateur, ne laissez pas tourner au-déla de 42'000 rpm pour un période plus longue.

Densité de l'air standard 1,2 kg/m³

			U51D2-024KX-5	U51D2-032KX-5
	U _N	V	24	32
	U	V	12.0-24.0	12.0-32.0
	I _N freeblowing	mA	3130	2772
	I _N work. point	mA	2901	2584
	I _N static	mA	1410	1278
	I _{block}	mA		
	P _N work. point	W	69.6	82.7
	n freeblowing	min ⁻¹	47337	49689
	n work. point	min ⁻¹	47809	50314
	n static	min ⁻¹	49281	51613
	V freeblowing	l/min	569	606
	V work. point	l/min	280	297
	p work. point	Pa	5910	6625
	p static	Pa	7952	8906
	LpA _(WP)	dB(A)	70	70
	MTTF _(WP)	hr	10'000 / 25°C	
	T	°C/°F	-20...+40 / -5...+105	
	m	gr/oz	256 / 9.03	
	Leads	mm/inch	450 / 17.7 (AWG24) / Connector Stocko MKFL 13268-6-0-808	
	Housing Material		ABS UL-94HB	
	Sleeve Bearing		N/A	N/A
	Ball Bearing		•	•
	Tacho		•	•

Datas of Blower were measured with controll board H015X-522A9